

TARGETTI

MINI MERCURE

Inground linear LED luminaire

Concept: Inground linear luminaire for monochromatic LEDs.

Housing: Black anodised die-cast aluminium body.

Materials: Antislip flush tempered safety glass, white silk-screen printed sealed to the fixture body.

Source: Strip LEDs.

Mounting: Suitable for inline installation configuration. To be installed with aluminium insertion box for horizontal mounting, to be ordered separately.

Installation: Pre-cabled with 10' Belden direct burial 18ga 2 Conductor Cable with IP68 Quick disconnects. See page 2 for Inline connection configurations.

Power Supply: Remote Class 2 110V-277VAC to 24VDC electronic power supply, see page 4 for maximum fixtures per driver. 0-10v dimming options also available. See page 3 for power supply options.

Wattage: 9W

Color Temperature: 3000°K / 4000°K

Lumens: 3000°K 4000°K
291 Lm 309Lm

Lumen Maintenance (L70): 50,000hrs

Calculation for LED fixtures are based on measurements that comply with IES LM-80.

CRI: 84

Voltage: 24V DC

IP: IP67

Load Rating: Resistant to static loads up to 12KN and dynamic loads up to 20KN in flush mounted cement and pavement installations.

Certifications: cULus Class 2 Wet Location Listed E479873

Tested in accordance with LM-79-08

Warranty: 5 year limited warranty

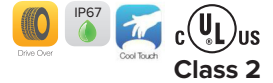

PRODUCT CODE	DRIVER	OUTPUT	COLOR TEMP	CABLE CONFIG.	+	INSERTION SLEEVE	+	POWER SUPPLY
MM — Mini MERCURE	RP — Remote Power	09 — 9W	30 — 3000K	L — Lead				
			40 — 4000K	C — Center				
				E — End				
				S — Solo				
				See Page 2 for inline cable configurations				

Views

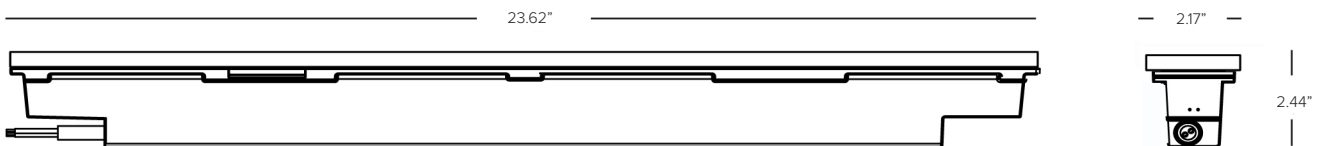

TARGETTI

MERCURE MINI

INSTALLATION (REQUIRED)	
1E2382	Vertical aluminium insertion boxes with pre-set with removable end caps for installations in continuous rows. Complete with internal supports for installations in concrete. Dimensions 23 ¹¹ / ₁₆ "L x 2 ¹ / ₄ "W x 3 ⁵ / ₁₆ "H.

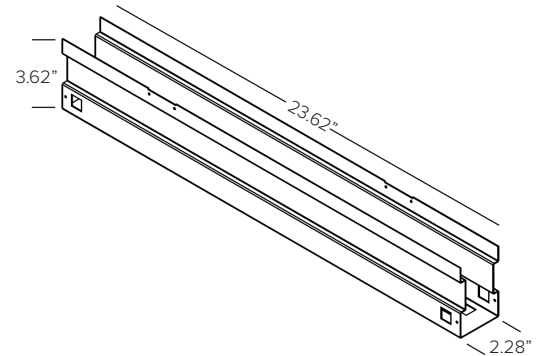
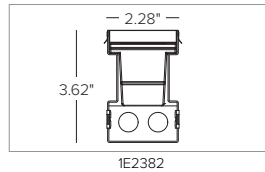

INSTALLATION ACCESSORIES:	
1E0388	Glass suction removal tool. Helpful one per 20 fixtures



CONNECTION CABLES	
MMWHTLEAD-xx	IP68 Additional lead cable, direct burial fixture cable with IP68 female 3 socket connector. Additional lead cables sold in 2 foot increments, from 12 foot (MMWHTLEAD-12) to 80 foot (MMWHTLEAD-80).
MMWHTJUMP-xx	IP68 Connector cord, 2ft direct burial cable for fixture to fixture connection with IP68 male 3 socket connector and IP68 female 3-pin connector. Connector cords sold in 2 foot increments, from 2 foot (MMWHTJUMP-02) to 20 foot (MMWHTJUMP-20).

Cable Connection Configuration

Fixture code: L

Lead Fixture
Includes 10ft power lead with female IP68 connection.

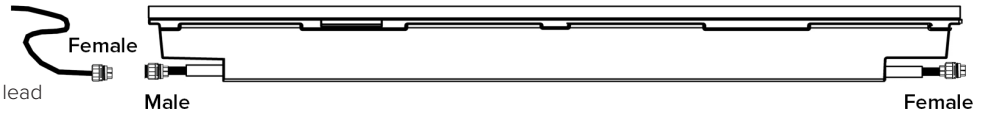

Fixture code: C

Center Fixture

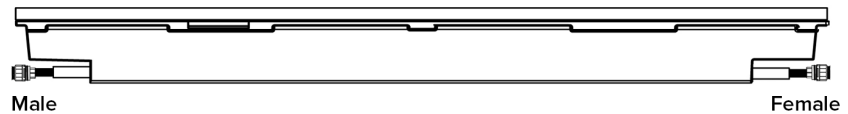

Fixture code: E

End Fixture

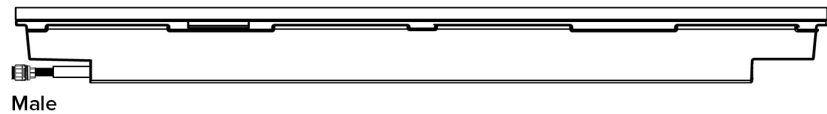

Fixture code: S

Solo Fixture
Includes 10ft power lead with female IP68 connection

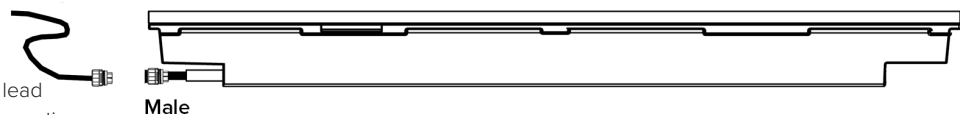

9W, 24V DC

A maximum of 8 fixtures can be attached together on a single Class 2, 4 amp circuit output. See page 4 for maximum fixtures per driver.

Power Supply (REQUIRED)	Type	Wattage	Input/Output Voltage	Dimmable	IP Rating	Output	Dimensions
DEL60PWM	ELECTRONIC PWM DRIVER STANDALONE, UL LISTED ENCLOSURE PROVIDED BY OTHERS	60W	120-277V / 24V	0-10V/PWM 10%	IP67	UR CLASS 2	5.9" X 2.09" X 1.38"
DEL90PWM	ELECTRONIC PWM DRIVER STANDALONE, UL LISTED ENCLOSURE PROVIDED BY OTHERS	90W	120-277V / 24V	0-10V/PWM 10%	IP67	UR CLASS 2	6.73" X 2.48" X 1.48"
DEDDxxx consult factory	ELECTRONIC 0-10V DRIVER STANDALONE, UL LISTED ENCLOSURE PROVIDED BY OTHERS	consult factory	120-277V / 24V	0-10V DIMMING 0.1%	N/A	UR CLASS 2	consult factory
DELV40124D	ELECTRONIC LOW VOLTAGE TRANSFORMER	40W	120-277V / 24V	PHASE (120V ONLY) /0-10V DIMMING 10%	IP66 / NEMA4 ENCLOSURE	UL CLASS 2	11" x 4" x 2.21" ¹
DELV60124D	ELECTRONIC LOW VOLTAGE TRANSFORMER	60W	120-277V / 24V	PHASE (120V ONLY) /0-10V DIMMING 10%	IP66 / NEMA4 ENCLOSURE	UL CLASS 2	11" x 4" x 2.21" ¹
DELV96124D	ELECTRONIC LOW VOLTAGE TRANSFORMER	96W	120-277V / 24V	PHASE (120V ONLY) /0-10V DIMMING 10%	IP67 / NEMA4 ENCLOSURE	UL CLASS 2	11" x 4" x 2.21" ¹
DELX601241CPWM	ELECTRONIC PWM DRIVER	60W	120-277V / 24V	0-10V/PWM 10%	IP67 / NEMA3R ENCLOSURE	UL CLASS 2	10" x 10" x 4" ¹
DELX901241CPWM	ELECTRONIC PWM DRIVER	90W	120-277V / 24V	0-10V/PWM 10%	IP67 / NEMA3R ENCLOSURE	UL CLASS 2	10" x 10" x 4" ¹
DELX1802242CPWM	ELECTRONIC PWM DRIVER	2X90W	120-277V / 24V	0-10V/PWM 10%	IP67 / NEMA3R ENCLOSURE	UL CLASS 2	12" x 12" x 4" ¹
DELX2703243CPWM	ELECTRONIC PWM DRIVER	3X90W	120-277V / 24V	0-10V/PWM 10%	IP67 / NEMA3R ENCLOSURE	UL CLASS 2	12" x 12" x 4" ¹

¹ Dimensions include enclosure with mounting bracket.

* Constant voltage drivers 50/60HZ, voltage regulated with short circuit protection. Operating temperature -40 C- 80° C

* Installation of power supply must be compliant to Class 2 installation standards. Refer to NEC and local building code requirements.

* Consult factory for additional driver options (ie: DMX, DALI, wattage, size, shape, Lutron, ELDO, or others).

MAX FIXTURES PER DRIVER

		Fixture Wattage						
		3W	4W	5W	6W	9W	10W	14W
Driver Wattage	40W	10	8	6	5	3	3	2
	60W	16	12	9	8	5	4	3
	96W	25	19	15	12	8	7	5
	90W	24	18	14	12	8	7	5
	2X90W	48	36	28	24	16	14	10
	3X90W	72	54	43	36	24	21	15
	100W	26	20	16	12	8	8	5
	2X100	53	40	32	26	17	16	11

TARGETTI

MERCURE MINI

Photometrics

